

Installation instructions for PZ4AL-03009-00, PZ4AL-03010-00
Under Run Protective Shield Engine Bay and Transmission Case

TOYOTA C-HR



Model year: **2018 -**

Applicability: NGX10L-AHFDXX
NGX50L-AHXEXX
ZGX10L-AHXGPX

Part Number: Steel: PZ4AL-03009-00
Aluminium: PZ4AL-03010-00
Installation kit: PZ4AL-03009-60



Weight: Steel: 9,78 kg
Aluminium: 7,08 kg



Installation Time: 30 min

Rev.2 22.06.2018

A

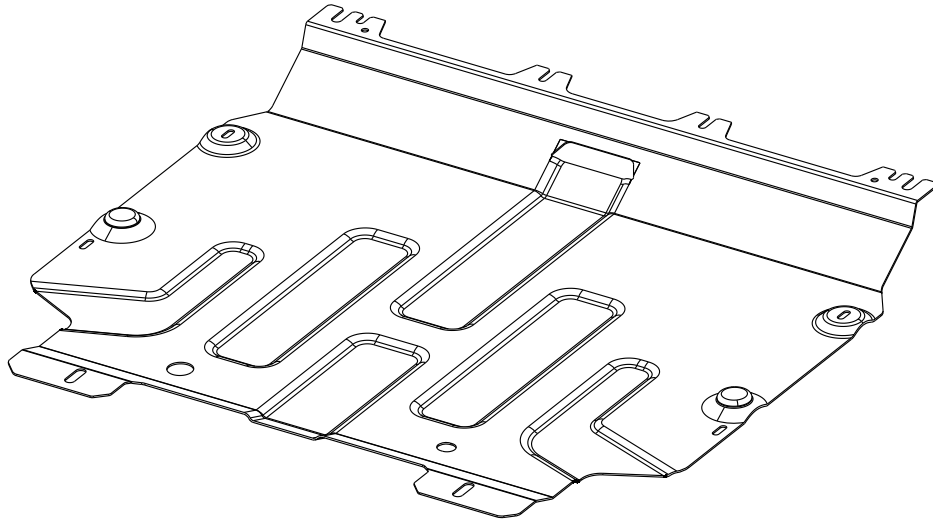

PZ4AL-03009-60

B

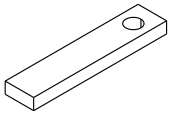

4x

C

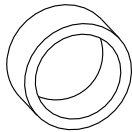

h=10 2x

D1

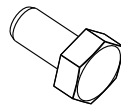

M6x30 4x

D2

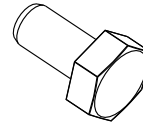

M8x20 2x

D3

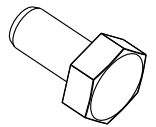

M8x30 2x

E1

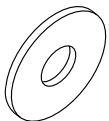

d=6

4x

E2

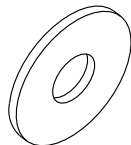

d=8

4x

F1



d=6

4x

F2

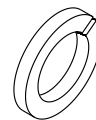

d=8

4x

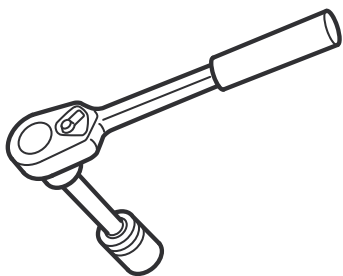

10 mm
13 mm

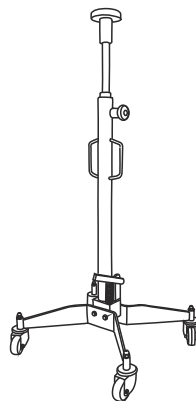

1

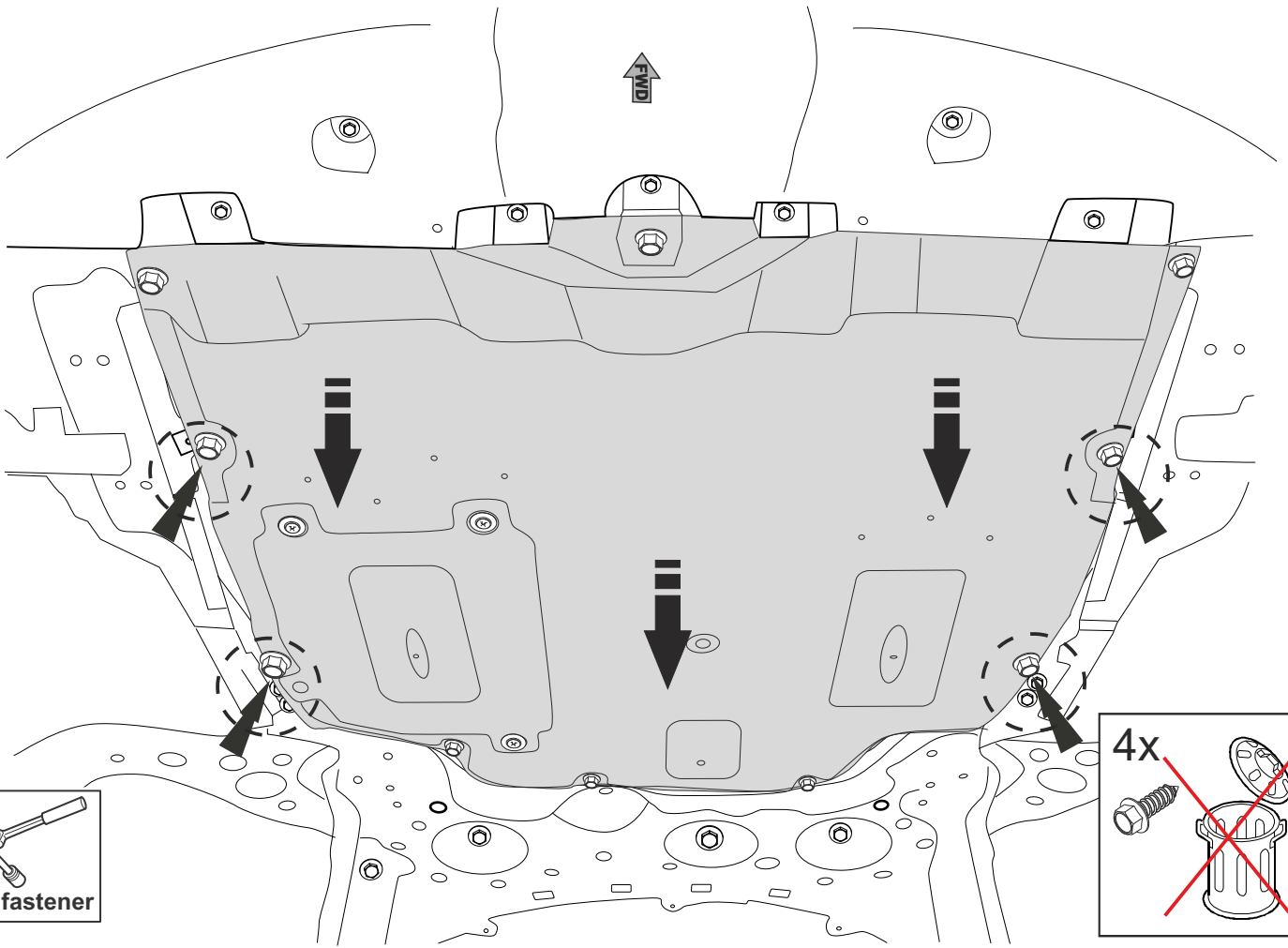

2

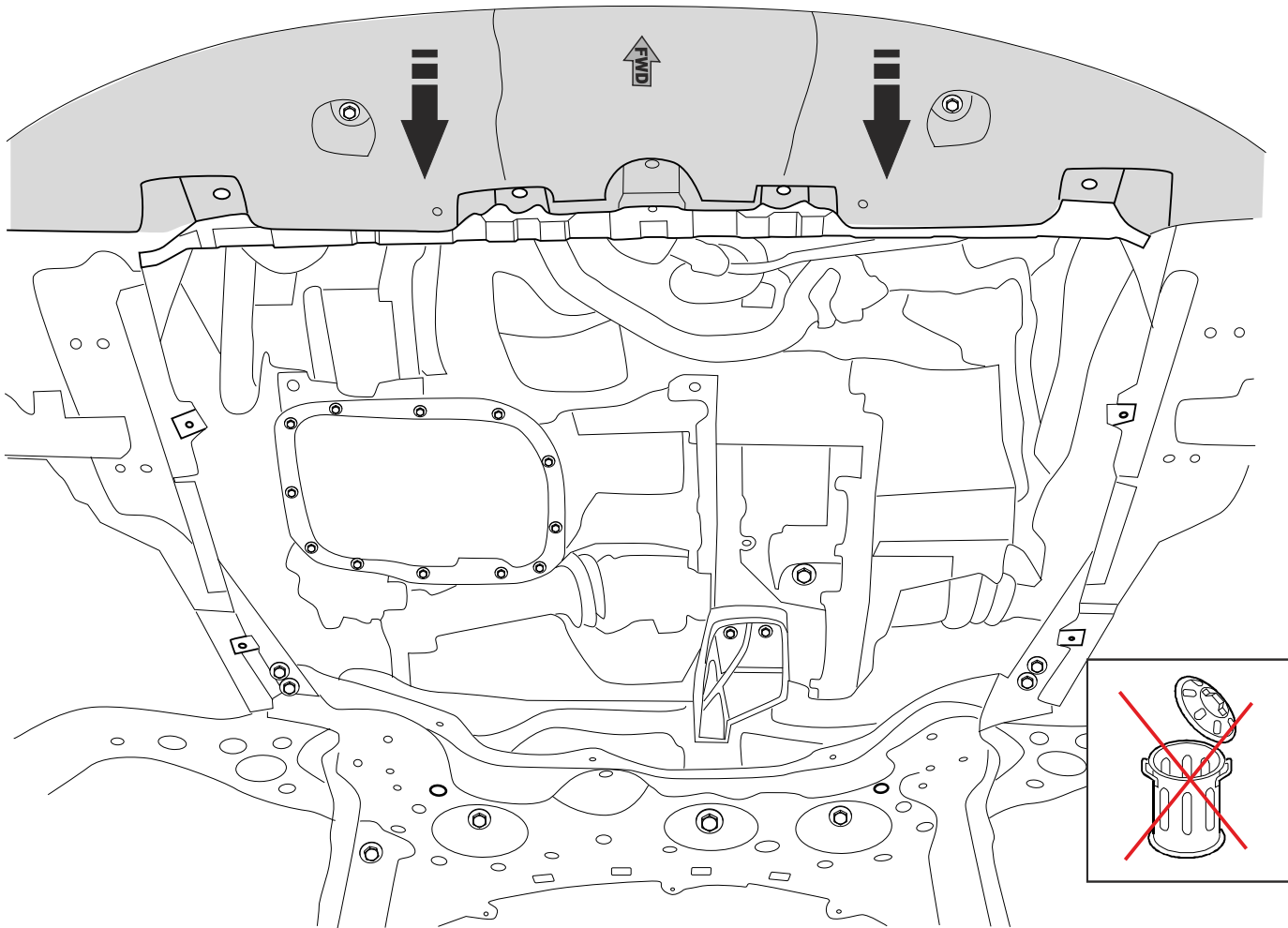

3

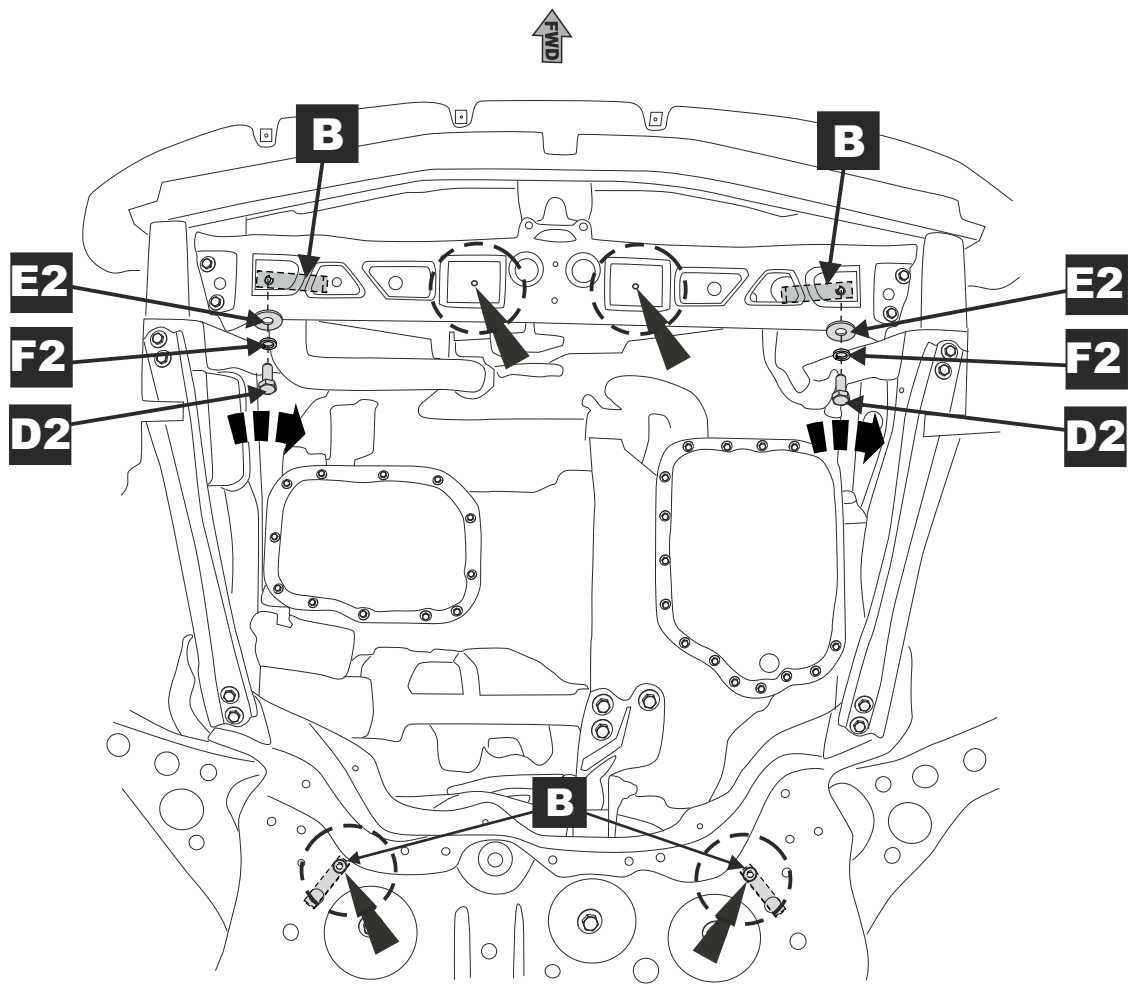

4

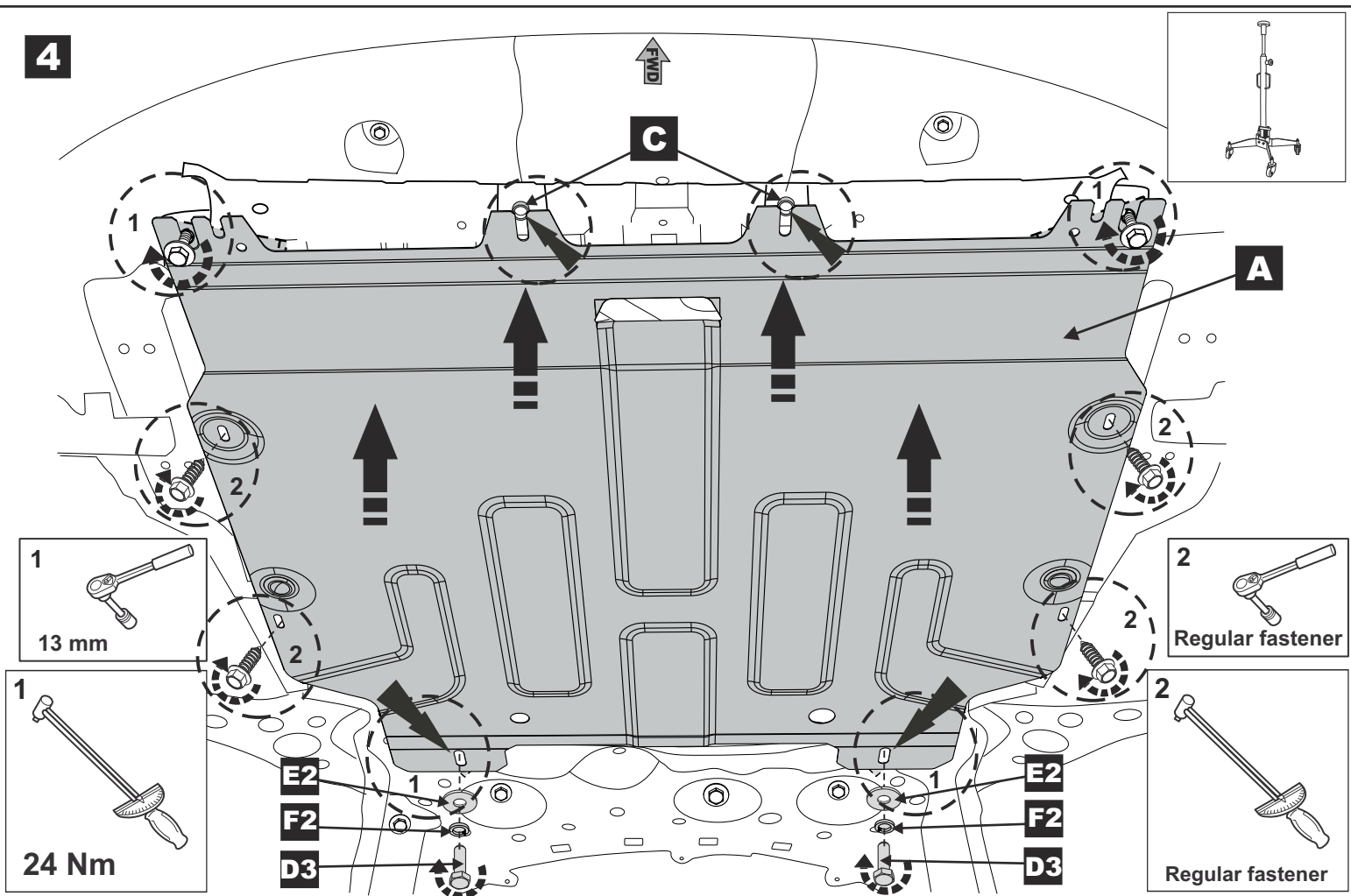

5

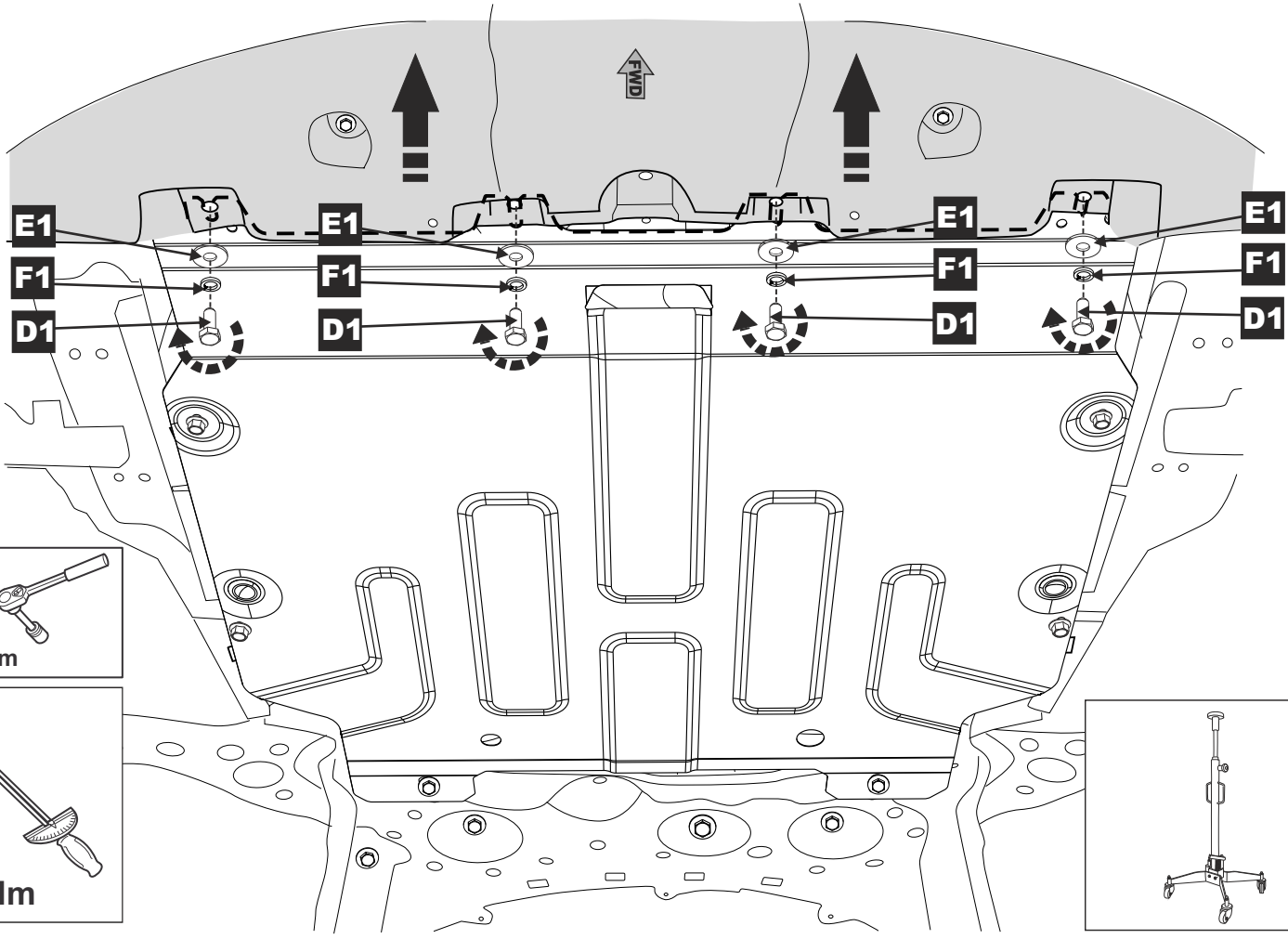

6

